



# **The report has 5 main components**

- **Abstract**
- **Introduction / Science**
- **Procedure**
- **Results & Analysis**
- **Conclusions**



# Title

- An **informative** title indicating main outcome
- Not just the title of your experiment, like “Optical Pumping”
- Next comes **names, affiliations, date**

Measurement of  $T_1$  and  $T_2$  Relaxation Times in Epoxy using PNMR

*An excellent student*

University of Illinois at Urbana-Champaign

9 February 2009



# Abstract

**A concise summary of what, why, how you found out, including main result and how it compares with expectation. 4 – 12 sentences at most. No details of the experiment and data analysis**

Measurement of  $T_1$  and  $T_2$  Relaxation Times in Epoxy using PNMR

*An excellent student*

University of Illinois at Urbana-Champaign

9 February 2009

## ABSTRACT

In this experiment, traditional PNMR techniques were used to study the relaxation times of an epoxy sample (Miller-Stephenson Epoxy 907) as it cured, with the aim of thus elucidating the reaction characteristics between its source reagents. It was discovered that  $T_1$  increased while  $T_2$  decreased with curing time. Consequently, it can be concluded that the curing process results in the formation of a rigid molecular structure, is exothermic, and proceeds at an approximately uniform rate.



# Abstract

*Celia's foolproof abstract recipe:*

*Answer the following questions, in this order, in one or two sentences each:*

**What problem did you study and why is it important?**

**What methods did you use?**

**What were your principal results?**

**What did you learn? What have you contributed?**

*courtesy of Celia Elliot*



# Abstract, typical problems

## ABSTRACT

Tin deposition on thin film samples are used in cryogenic tests. The critical temperature for which the samples become superconductive is determined using the thickness of the sample and the critical current.

**Too short and no real information about the material under study, nothing about findings/results.**



# Abstract, typical problems

## Abstract

In this paper we report the experimental results and analysis of the critical temperature ( $T_c$ ) and critical current ( $I_c$ ) determination related to aluminum superconductivity in thin films of varying thickness  $d$  between 80 °Å and 130 °Å. Resistance vs. temperature measurements **are made on each sample**, and show good agreement with **Bardeen-Cooper-Schrieffer** (BCS) theory **for transitions into superconducting state (adj.  $R^2= 0.973$ )**. A rough trend in the correlation between critical temperature  $T_c$  and sample thickness was found. Critical current vs. temperature showed good correlation with BCS theory **(adj.  $R^2 = 0.969$ )** but **predicted** a different critical temperature than the  $RT$ -curve method within 10%. The  $T_c$  found by our methods are much higher than the accepted value for bulk aluminum, indicating that we might have observed the enhancement of superconductivity in thin films. Various factors that might affect the outcome of the experiment, such as size effect and sample degradation by oxidation, as well as means for future improvements, are discussed.

**Not bad but too many complimentary details which can be omitted from Abstract and discussed elsewhere in the text of the report**





# Introduction / Science

- Background information and context but **not a long historical excursion**
- Physics diagrams, energy levels, phase conventions, etc. depending on the experiment
- **Motivation and what you are trying to learn – state overall idea and main result**

## INTRODUCTION<sup>1,2</sup>

Continuous-Wave Nuclear Magnetic Resonance (CWNMR) was discovered by Edward Purcell and Felix Bloch in 1946, for which they were awarded the Nobel Prize in Physics in 1952. From the principles laid down by Purcell and Bloch for CWNMR, techniques such as Magnetic Resonance Imaging (MRI) have been developed. The technique of Pulse NMR (PNMR) used in this experiment was developed by Erwin Hahn in 1950.

### Scientific Basis

The basis of both forms of NMR is the intrinsic magnetic moment  $\vec{\mu}$  of the nucleus. Semi-classically, this is tied to the nucleus' angular momentum  $\vec{L}$  and gyromagnetic ratio  $\gamma$  by the equation

$$\vec{\mu} = \gamma \vec{L} \quad (1.1)$$

In a magnetic field  $\vec{B}_0$ , the nucleus will experience a potential given by

$$\begin{aligned} U &= -\vec{\mu} \cdot \vec{B}_0 \\ U &= -\gamma \vec{L} \cdot \vec{B}_0 \end{aligned} \quad (1.2)$$



# Introduction / Science

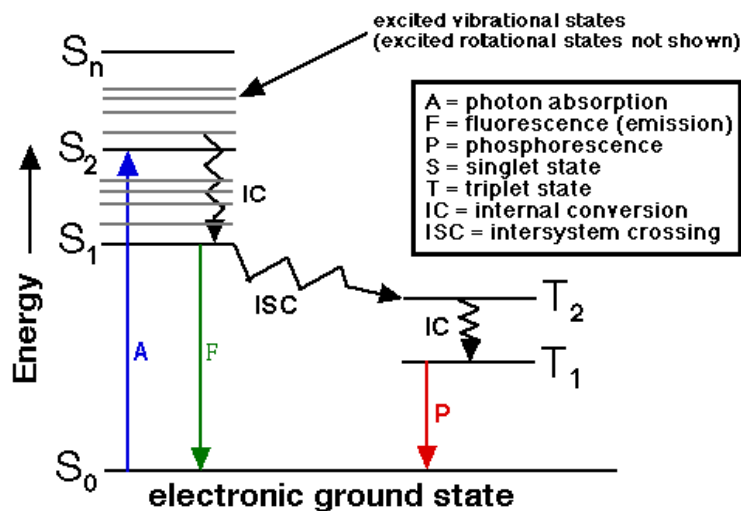

Figure 1. An electron's excitation and de-excitation can be seen to travel through different energy states, including spin singlet states and triplet states. The difference between the singlet and triplet states comes from the different interactions between the parallel and anti-parallel spins of the electron.



# Procedures ...

- **What** you did and **how** you did it – not just a list
- **Diagrams of electronics, setup layout, topology, scope shots** if appropriate
- Photo if it helps **but not a picture gallery**
- **Not an instruction manual** – assume basic knowledge and give enough information so others can reproduce the experiment



# Procedures ...



short flexible tubing

Wastebasket where liquid nitrogen is removed

Picture A: Liquid nitrogen is being removed from the cryostat.



Picture B: Close-up of the liquid nitrogen being transferred.

An example of useless pictures



superinsulated cryostat



# Procedures ...

## Calibration

Due to environmental factors such as temperature changes, the field supplied by the permanent magnet is not constant. Consequently, the resonant frequency will be affected (see Eqn. 1.4) and must be adjusted periodically to reflect this. To facilitate such adjustments, the Mixer unit multiplies the precession signal from the sample and the input signal from the oscillator, producing an output signal that will exhibit beating should the frequencies of the two input signals not match (Fig. 1a.). Tuning was done by adjusting the oscillator frequency until the beating effect disappeared (Fig. 1b.). It is suggested by the accompanying literature that tuning should be done ~every 15min; over the course of the experiment, it was noticed that the permanent magnetic field does indeed show appreciable changes over such a span of time.

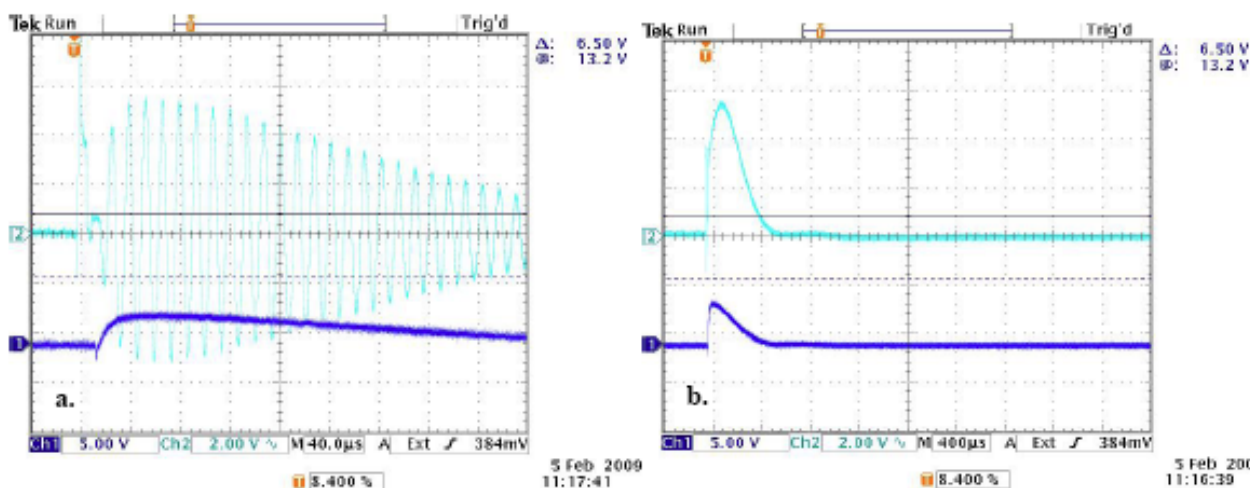
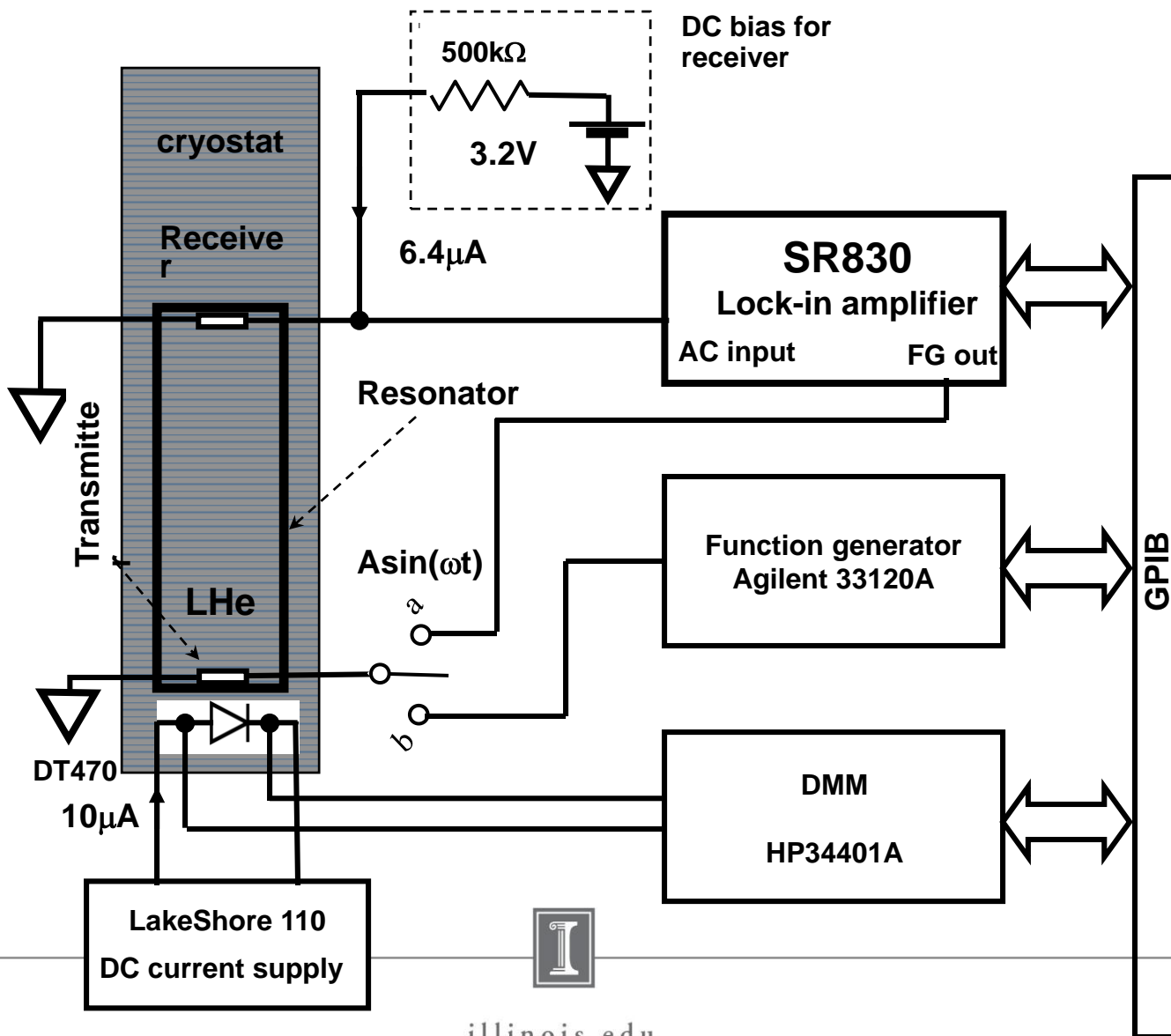

Figure 1. Example of a mixer signal (light blue trace) a. with beating; b. without beating. Thus, the oscillator is tuned to the resonant frequency in b.; the trace in dark blue is the precession signal.



# Procedures ...



# Procedures ...

PMN-PT 10% (111)

Connection #1

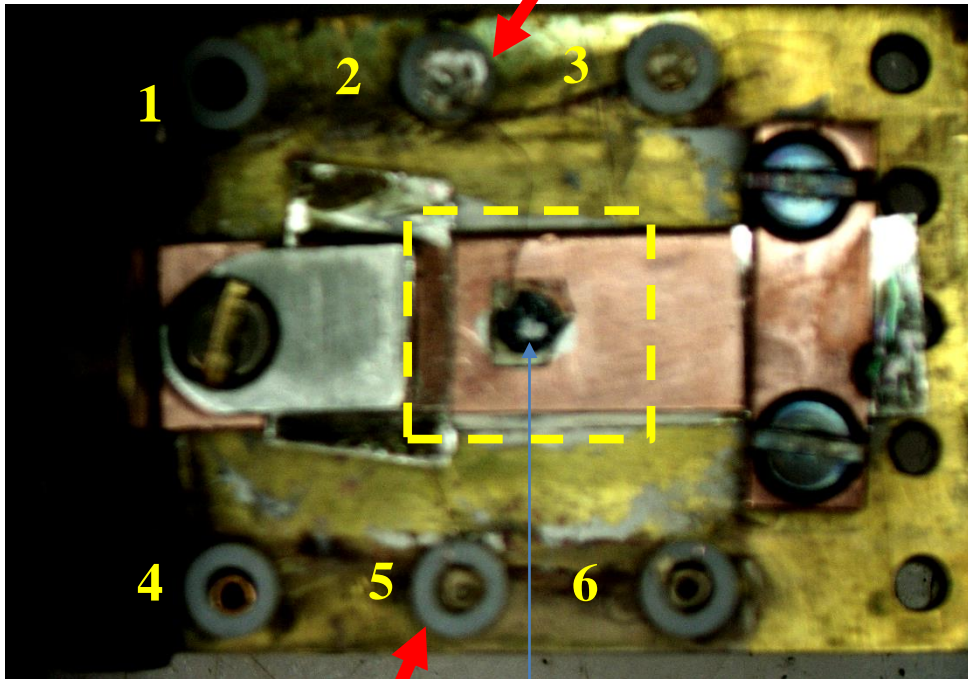

Sample parameters:  
thickness: 0.37mm  
Area: 7.07mm<sup>2</sup>

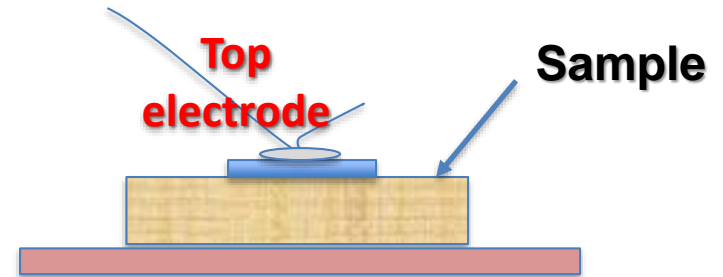

Connection #2

Sample

BNC connectors no3 and no6

Samples, sample preparation



# Results & Analysis

- The **conversion** of raw data into a **physics result**
- Perhaps tables of raw data if appropriate
- **Plotting and data fitting**
- **Interpretation of fits and data**
- **Physics conclusions**
- **Discussion of uncertainties**





# Analysis ...

| Glycerin added (g) | Approximate percentage of glycerin by weight | water added (g) | Final percentage of glycerin by weight |
|--------------------|--|-----------------|--|
| 3.517              | 100  | 0               | 100                                    |
| 9.959              | 97.5   | 0.255           | 97.5                                   |
| 5.76               | 95   | 0.288           | 95.2                                   |
| 1.816              | 90   | 0.245           | 88.1                                   |
| 3.500              | 80   | 0.876           | 80.0                                   |
| 3.512              | 70   | 1.495           | 70.1                                   |
| 3.525              | 60   | 2.357           | 58.2                                   |
| 3.514              | 40   | 5.298           | 40.0                                   |
| 3.525              | 20   | 14.33           | 19.7                                   |

Table 1. The glycerin concentration of the prepared sample and the amount of glycerin and water added to the sample.

**Data collected in table**



# Analysis ...

## Magnetic Field in XY plane

Contour Graph of Magnetic Field Strength at  $z = 17.1$  cm

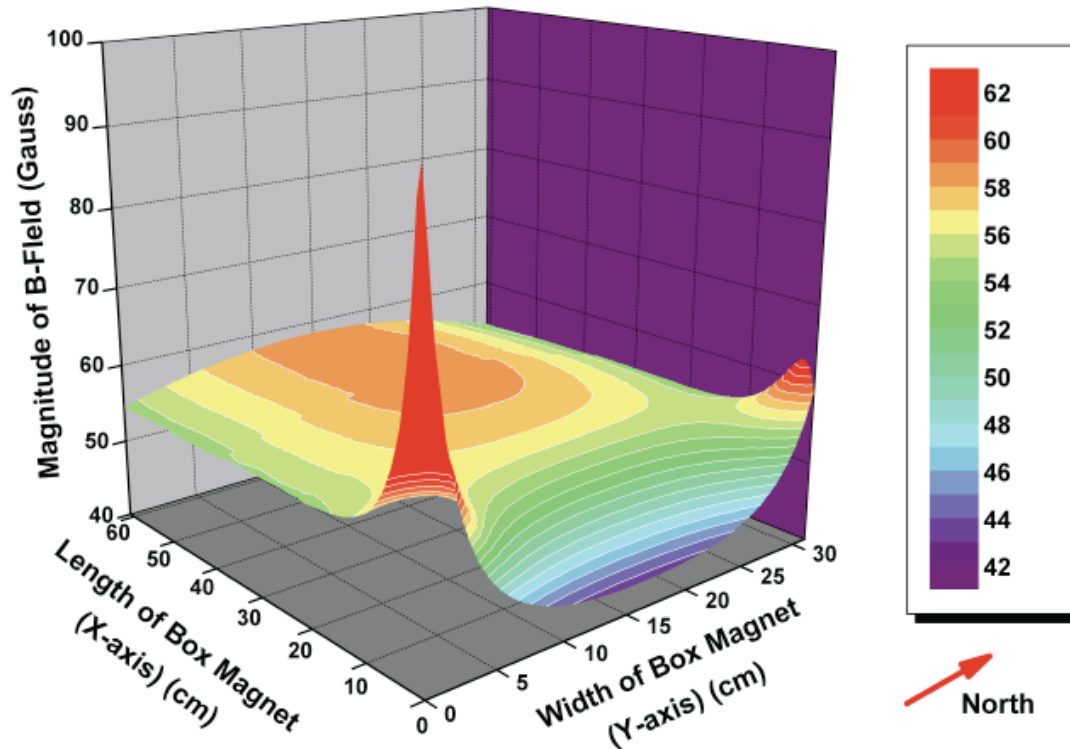

Figure 1.8 Contour graph of magnetic field strength within box magnet. The origin is at the South East corner of the box magnet. Magnitudes above 62 Gauss are colored in red.

Graphs



# Analysis ...

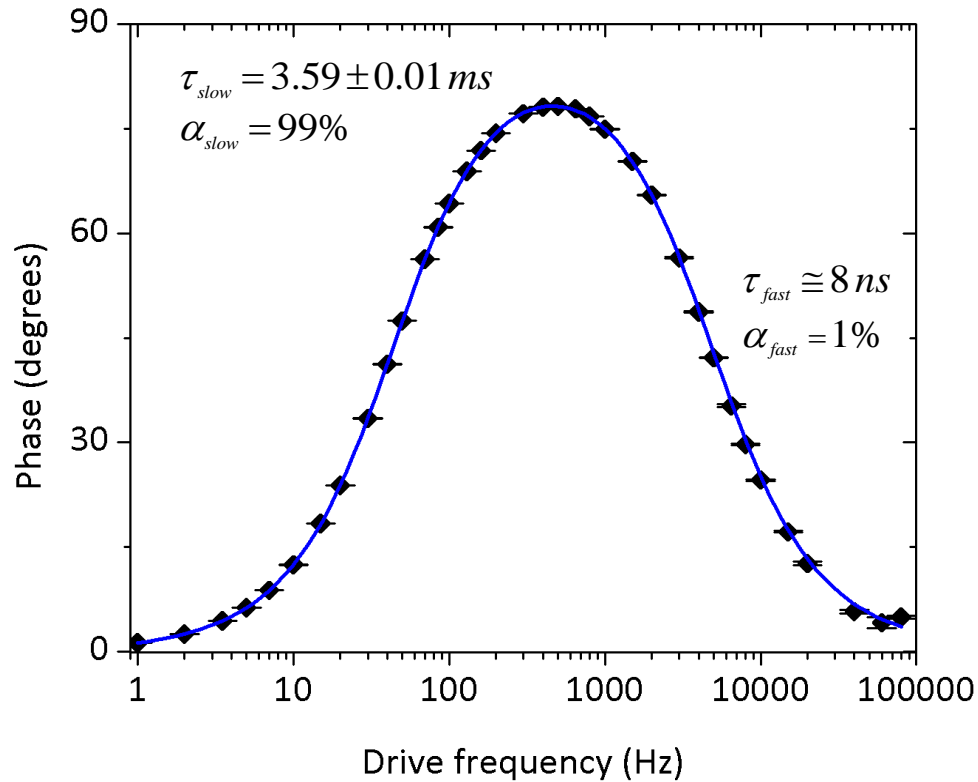

Figure 6. The phase of the ruby fluorescence response to a squarewave excitation is plotted for select driving frequencies from 1 Hz to 80 kHz. A fit to the two-component phase model is plotted in blue.

Graphs



# Analysis ...

## Na<sup>22</sup> Angular Correlation

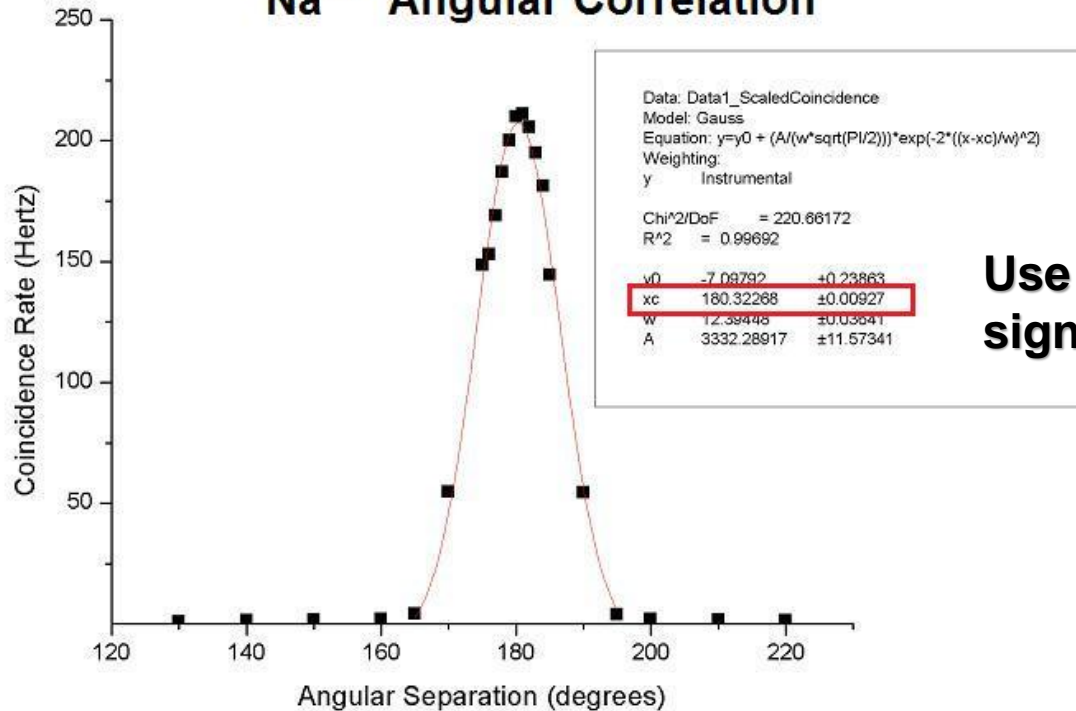

**Use correct number of significant figures!**

Figure 8: The coincidence rate between Det A and Det B as a function of angular separation between them. Since the positronium that annihilates to emit two 511 KeV gamma rays is in the lab frame, momentum conservation predicts a delta function of coincidences at 180 degree separation.



# Analysis ...

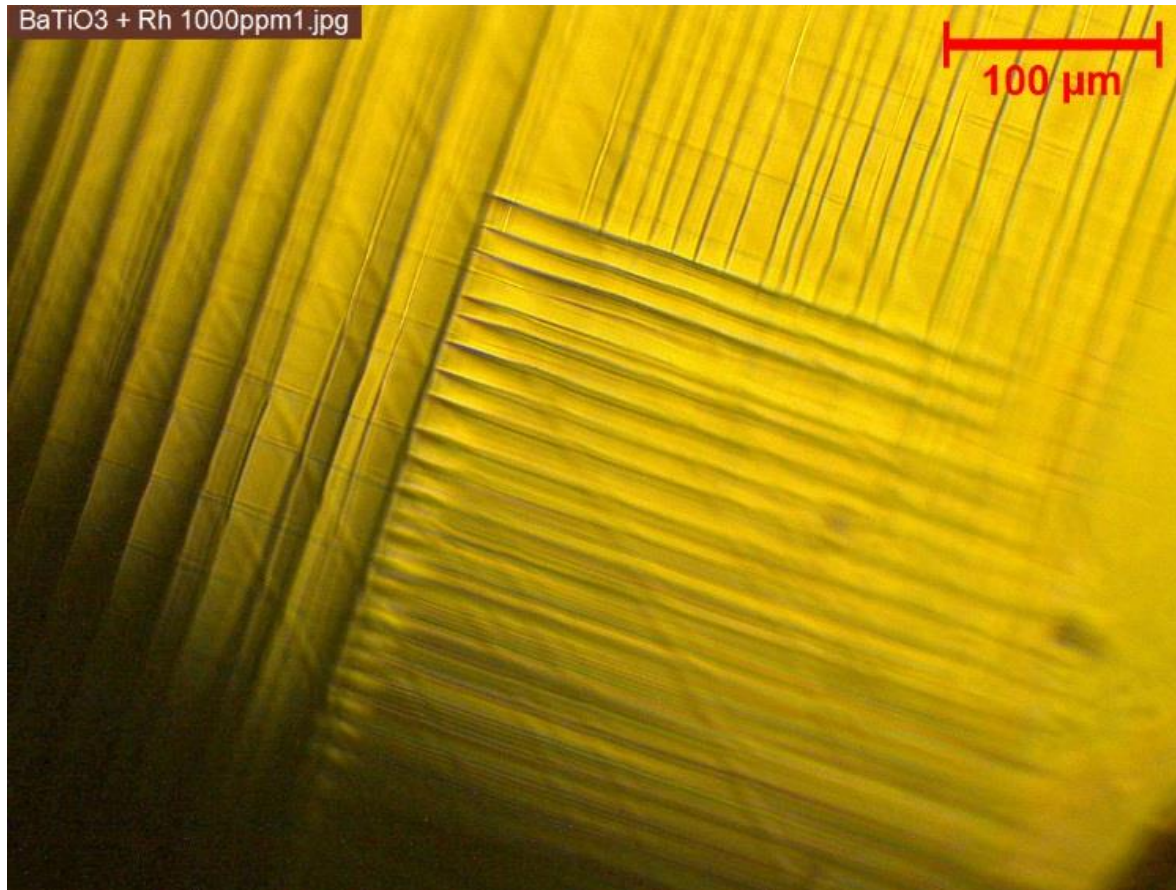

**Microscope images**



# Discussion (if needed)

## DISCUSSION

Although both tests presented results that concurred with expectations, it must be noted that the  $T_2$  results, with its more consistent fits and trends, is therefore more reliable than the collected  $T_1$  data. Problems encountered when collecting  $T_1$  data included a significant amount of signal noise, sometimes as high as 0.02V – this is why the  $T_1$  fits were conducted without the data points immediately preceding and following the zero crossing, and also why the zero crossing method cannot be implemented as a secondary method for calculating  $T_1$ .

Secondly, it was observed that an anomalous signal peak appeared to the left of the expected decay peak at Delay Times above 10ms. Although the presence of this peak is unexplained, it would no doubt have had an influence on the weaker decay peaks, likely introducing a gain in the peak height. Additionally, it poses the problem of having the observer judge where signal data should be observed and collected from, since the additional peak initially manifests itself as a seeming shift in the decay peak to the left; at Delay Times of 30ms and higher, however, it becomes progressively clearer that this anomalous peak is not indeed the desired decay signal. Despite this, however, the anomalous peak does display variations with curing time similar to that of the decay peak (although not quite as pronounced); thus, it may be of value to study the source and characteristics of this peak.

## Ideas for possible improvements or next steps of the experiment?



# Conclusions

Concise summary of **what you did and what you found out**. This is not a long section

## CONCLUSION

The studied epoxy sample, with its increasing  $T_1$  and decreasing  $T_2$ , presented results that generally concurred with expected trends. With a greater pool of data appropriate cross-referencing, it is conceivable that PNMR could be used as a non-invasive means of determining the extent of curing of an epoxy sample. Using the same principles, PNMR could be used to ascertain the energetics and kinetics of other reactions as well.

---

<sup>1</sup> TeachSpin Inc., *PSI-A User's Manual*, 2000.

<sup>2</sup> UIUC Department of Physics, *Pulsed Nuclear Magnetic Resonance Lab Notes*, 2002.

<sup>3</sup> M. Soo, *Results for T1*, [www.npl.illinois.edu/elog/modphys/ModPhysLabFall2008/91](http://www.npl.illinois.edu/elog/modphys/ModPhysLabFall2008/91), 7 Oct. 2008.

<sup>4</sup> M. Soo, *T2*, [www.npl.illinois.edu/elog/modphys/ModPhysLabFall2008/97](http://www.npl.illinois.edu/elog/modphys/ModPhysLabFall2008/97), 9 Oct. 2008.

<sup>5</sup> H. Kimoto et al, *Analytical Sciences*, 2008, 24, 915.

<sup>6</sup> MIT Department of Physics, *Pulsed Nuclear Magnetic Resonance: Spin Echoes*, 31 Jan. 2008.





# References

## 1 Introduction and theory

Optical pumping was introduced by Alfred Kastler in 1950 and has since been a useful tool for aligning the spins of suitable atoms. It generally refers to a process which uses photons to redistribute the electronic states occupied by a collection of atoms [1]. In this experiment, vaporized atoms of rubidium-85 ( $^{85}\text{Rb}$ ) and rubidium-87 ( $^{87}\text{Rb}$ ) were used to observe various effects such as Zeeman splitting, Larmor precession, and other transient effects.

### References:

There should be link to references in text

1. TeachSpin, Inc., OP1-A Instructor's Manual, (2002).
2. J. Recht and W. Klein, Optical Pumping of Rubidium, University of Wisconsin Laboratory Notes, (2005).
3. E. D. Black, Optical Pumping, California Institute of Technology Laboratory Notes, (27 Sep. 2004).



# Appendix

## APPENDIX

### tdcsumfit.cpp

```
doit()
{
MuLife->Draw("TDCSUM/500>>SUM(200,0,8)", "", "");
SUM->SetYTitle("Counts");
SUM->SetXTitle("Time [us]");
SUM==SUM;
user=new TF1("user", "[0]*exp(-(x-0.1)/([1]))+[2]*exp(-(x-
0.1)/([3]))+[4]", .1, 7.5);
user->SetParameters(300, 2.2, 250, 0.85, 10);
user->SetLineColor(4);
user->SetParNames("Ratio:
Plus/Minus", "TauPlus", "AmpMinus", "TauMinus", "Background");
SUM->Fit("user", "R");
}
```

### tdcsumfit2.cpp

```
doit()
{
MuLife->Draw("TDCSUM/500>>SUM(200,0,8)", "", "");
SUM->SetYTitle("Counts");
SUM->SetXTitle("Time [us]");
SUM==SUM;
user=new TF1("user", "[0]*[2]*exp(-(x-0.1)/([1]))+[2]*exp(-(x-
0.1)/([3]))+[4]", .1, 7.5);
user->SetParameters(1.2, 2.2, 250, 0.85, 10);
user->SetLineColor(4);
user->SetParNames("Ratio:
Plus/Minus", "TauPlus", "AmpMinus", "TauMinus", "Background");
SUM->Fit("user", "R");
```



# How long?

- **~7 – 15 pages**
- **If you have lots of plots or photos that serve to complete your work, you can put them in an appendix if you really just want to keep all the stuff together**



# **In addition, a good report is technically solid**

- **Spell-checked, grammar-checked and proofread**
- **Equations are numbered**
- **Figures are clear and polished**
  - **Font size is readable**
  - **Diagrams correctly represent your experiment (if not, modify!)**
  - **Drawings are not blurry – do not use a photo of a diagram, but rather the original diagram**
- **Figures & tables are numbered & have captions**
  - **When referring to a figure in the text, use its number: e.g. “As shown in Fig. 1...”**
  - **Captions contain enough information so that the figure/table and its caption could be clipped out and viewed separately**



# Lab Report (100 pts) Grading Method

| <b>CRITERIA</b>   | <b>Eugene</b> | <b>Virginia</b> |
|---|---------------|-----------------|
| <b>Science overview (20)</b>  |               |                 |
| <b>Procedures (30)</b>  |               |                 |
| <b>Results / Analysis (30)</b>  |               |                 |
| <b>Technical quality of the report: graphs, figure captions, tables, references, check spelling etc. (20)</b> |               |                 |
| <b>Final Totals (100)</b>   |               |                 |



# Late Reports

- **Policy for late reports**

- You can have **ONE “late ticket”** for a “free” delay of up to **3 business days**, but you must tell us you are using the ticket
- Reports are due at midnight on the date shown on the syllabus. After that we will charge:
  - 5 points for up to 1 week late. 10 points for up to 2 weeks late.
  - After that, it's too late.



C1-Ex1(2.07.18)

**You can RESUBMIT one lab  
report to improve your grade  
(deadline for resubmissions  
May 8<sup>th</sup> )**





# Written Report Examples

- **Examples of good (not perfect!) reports are at**  
**PHYCS403/Common/ExampleTalks-Reports**

